

MARCIA

Item No. 353P08

START HERE

1. Find a clear area in which you can work.
2. Unpack fixture from the box.
3. Carefully review the instruction prior to assembly.

-
1. Shut off electrical current before starting. If the fixture you are replacing turned ON and OFF by a wall switch, simply turn the switch off. If not, remove the appropriate fuse (or open the circuit breaker) until the fixture is dead. **DO NOT** restore current- either by fuse, breaker, or switch- until the new fixture is completely wired and in place.
-

STEP 1

1. It is necessary to determine the amount of chain that will be required to hang your fixture at the desired height.
 2. Next to begin assembly slip the center stem (1) along the wire and thread onto the threaded tube (2) and tighten.
 3. Now take the desired amount of chain and attach it to the loop at the top of the center stem (1).
 4. Fixture is ready to be mounted to the ceiling.
 5. Follow instruction sheet VIS-01, provided.
-

SAFETY WARNING: READ WIRING AND GROUNDING INSTRUCTIONS AND ANY ADDITIONAL DIRECTIONS. TURN POWER SUPPLY OFF DURING INSTALLATION. IF NEW WIRING IS REQUIRED, CONSULT A QUALIFIED ELECTRICIAN OR LOCAL AUTHORITIES FOR CODE REQUIREMENTS.

1. After your fixture is installed, you can now be lamped accordingly.

DRAWING 1

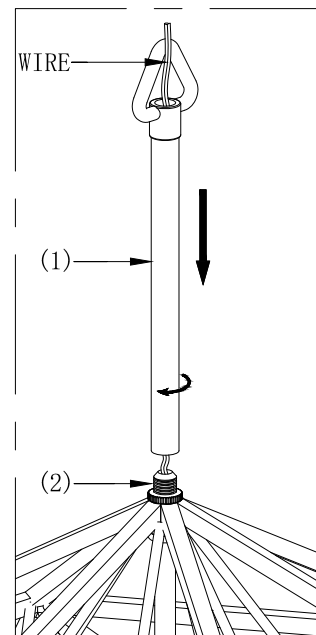

Safety Instructions

KEEP THESE INSTALLATION INSTRUCTIONS

▲ WARNING: FOR YOUR PROTECTION AND SAFETY - Carefully read and understand the information given in this manual before beginning the assembly and installation. Failure to do so could lead to electric shock, fire or other injuries which could be hazardous or even fatal. PRODUCT MUST BE INSTALLED BY A PERSON FAMILIAR WITH THE CONSTRUCTION AND OPERATION OF THE PRODUCT AND THE HAZARDS INVOLVED IN ACCORDANCE WITH THE APPLICABLE INSTALLATION CODE.

1. All electrical connections must be in agreement with local codes, ordinances or the national electric code (NEC). Contact your municipal building department to learn about your local codes, permits and/or inspections. WARNING: RISK OF FIRE - MOST DWELLINGS BUILT BEFORE 1985 HAVE SUPPLY WIRE RATED FOR 60°C. CONSULT A QUALIFIED ELECTRICIAN BEFORE INSTALLATION.
2. TURN OFF ELECTRICITY at main fuse box (or circuit breaker box) before beginning installation by switching circuit breaker off or removing fuse.
3. DO NOT connect this fixture to an electrical system that does not provide a means for equipment grounding. Never use a fixture in a two-wire system that is not grounded. WARNING: INSTALLING A FIXTURE INTO AN ELECTRICAL SYSTEM NOT HAVING A PROPER GROUNDING MEANS COULD ALLOW ALL METAL PARTS OF THE FIXTURE TO CARRY ELECTRICAL CURRENT IF ANY OF THE FIXTURE WIRES, WIRE CONNECTIONS OR SPLICES BECOME BROKEN, CUT OR LOOSE DURING THE MOUNTING OR NORMAL OPERATION OF THE FIXTURE, UNDER THIS CONDITION, ANYONE COMING IN CONTACT WITH THE FIXTURE IS SUBJECT TO ELECTRICAL SHOCK, WHICH COULD CAUSE SERIOUS INJURY OR DEATH.
4. If you are not sure your lighting system has a grounding means, DO NOT attempt to install this fixture. Contact a qualified, licensed electrician for information with regards to proper grounding methods as required by the local electrical code in your area.
5. DO NOT connect the bare or green insulation fixture ground wire to the black (HOT) current carrying wire or white neutral house wire. WARNING: CONNECTION OF THE BARE OR GREEN FIXTURE GROUND WIRE TO THE BLACK OR WHITE HOUSE WIRES MAY ALLOW ALL METAL PARTS OF THE FIXTURE TO CARRY ELECTRICAL CURRENT. UNDER THIS CONDITION ANYONE COMING IN CONTACT WITH THE FIXTURE WILL RECEIVE ELECTRICAL SHOCK, WHICH COULD CAUSE SERIOUS INJURY OR DEATH.
6. DO NOT suspend any fixture by the house wires. A fixture must always be mounted directly to an outlet box or to a mounting strap which is first attached to the outlet box. WARNING: WIRE CONNECTORS WILL NOT SUPPORT THE WEIGHT OF A FIXTURE. SUSPENDING A FIXTURE BY THE HOUSE WIRES AND WIRE CONNECTORS WILL RESULT IN THE FIXTURE FALLING, WITH THE POSSIBILITY OF PERSONAL INJURY AND THE DANGER OF ELECTRICAL SHOCK OR FIRE.
7. All fixtures must be mounted to an outlet box that is supported by the building structure. DO NOT attempt to support the fixture by ceiling board alone. Ceiling board alone does not have the strength to support the weight of the fixture. The fixture may fall and cause personal injury.
8. BE CAREFUL not to damage or cut the wire insulation (covering) during fixture installation. DO NOT permit wires to contact any surface having a sharp edge. To do so may damage or cut the wire insulation which could cause serious injury or death from electric shock.
9. DO NOT use lamps (bulbs) having a greater wattage than the maximum value stated on the fixture. The use of a higher wattage lamp(s) than specified will increase temperatures and cause the risk of fire.
10. If a dimmer control switch is used with this fixture, obtain professional advice to determine the correct type and electrical rating required.

Instrucciones de seguridad

GUARDE ESTAS INSTRUCCIONES DE INSTALACIÓN

▲ ADVERTENCIA: PARA SU PROTECCION Y SEGURIDAD- Lea cuidadosamente y obtenga una clara idea de la información en este manual antes de iniciar el ensamblaje e instalación descrita en las páginas que siguen. El ignorar esto podría causar un choque eléctrico, incendio u otros daños que pueden ser peligrosos y hasta fatales. PRODUCTO DEBE SER INSTALADO POR UN FAMILIAR CON LA CONSTRUCCIÓN Y EXPLOTACIÓN DEL PRODUCTO Y LOS PELIGROS QUE PARTICIPAN DE ACUERDO CON EL CÓDIGO DE INSTALACION CORRESPONDIENTE.

1. Todas las conexiones eléctricas deben estar de acuerdo con el código y las ordenanzas locales, o el código eléctrico nacional (NEC, siglas en inglés). Póngase en contacto con el departamento de construcción de la municipalidad para ilustrarse respecto a los códigos, licencias y/o inspecciones locales. ADVERTENCIA: RIESGO DE INCENDIO - LA MAYORIA DE EDIFICIOS CONSTRUIDOS ANTES DE 1985 TIENEN CABLES DE ALIMENTACION CON CAPACIDAD TERMICA NOMINAL DE 60°C. CONSULTE CON UN ELECTRICISTA CALIFICADO ANTES DE LA INSTALACION.
2. CORTE LA ELECTRICIDAD en la caja principal de fusibles (o la caja del interruptor automático) antes de comenzar la instalación, apagando el interruptor o quitando el fusible.
3. NO CONECTE este artefacto a un sistema eléctrico que no tiene conexión a tierra. Nunca use un artefacto en un sistema eléctrico de dos cables sin conexión a tierra. ADVERTENCIA: EL INSTALAR UN APARATO EN UN SISTEMA SIN CONEXION A TIERRA APROPIADA, PODRIA CAUSAR QUE TODAS LAS PARTES METALICAS DEL APARATO SE ELECTRIFIQUEN. SI SUCEDE QUE CUALQUIERA DE LOS CABLES DEL APARATO, LAS CONEXIONES O EMPALMES SE ROMPAN, SE CORTEN O SE SUELTEN DURANTE EL ENSAMBLAJE O LA OPERACION DEL APARATO, ENTONCES CUALQUIER PERSONA QUE SE PONGA EN CONTACTO CON EL APARATO ESTA EN PELIGRO DE RECIBIR UN CHOQUE ELECTRICO QUE PUEDE CAUSAR LESIONES GRAVES Y AUN LA MUERTE.
4. Si usted no está seguro de que su sistema de alumbrado tiene medios para conexión a tierra, NO INTENTE instalar este aparato. Contacte a un electricista licenciado y calificado para informarse sobre métodos apropiados para instalar la conexión a tierra requerida por el código eléctrico de su localidad.
5. NO CONECTE el cable a tierra desnudo o el de aislamiento verde, al negro (POSITIVO) portador de la electricidad o al blanco neutro proveniente de la casa. ADVERTENCIA: EL CONECTAR EL CABLE A TIERRA DESNUDO O EL VERDE DEL APARATO, AL CABLE NEGRO O AL BLANCO DE LA CASA, PUEDE HACER QUE TODAS LAS PARTES METALICAS DEL APARATO SE ELETRIFIQUEN. BAJO ESTAS CONDICIONES CUALQUIER PERSONA QUE SE PONGA EN CONTACTO CON EL APARATO RECIBIRA UN CHOQUE ELECTRICO QUE PUEDE CAUSAR LESIONES GRAVES Y AUN LA MUERTE.
6. NO CUELQUE ningún aparato de los alambres eléctricos de la casa. Un aparato siempre debe montarse directamente a una caja de salida o a una barra para artefactos previamente montada sobre la caja de salida. ADVERTENCIA: LOS CABLES DE CONEXION NO SOPORTARAN EL PESO DE UN APARATO. EL COLGAR DE LOS CABLES DE LA CASA Y LOS CONECTORES RESULTARA EN LA CAIDA DEL APARATO Y LA POSIBILIDAD DE LESIONES PERSONALES Y EL PELIGRO DE CHOQUE ELECTRICO O INCENDIO.
7. Todos los aparatos deben sujetarse a una caja de salida que esté sujeta a la estructura del edificio. NO INTENTE sujetar el aparato solamente al cielo raso. El cielo raso no tiene la fuerza para soportar el peso del aparato. El aparato se puede caer y causar lesiones personales.
8. TENGA CUIDADO de no dañar o cortar el aislamiento (la cubierta) del cable durante la instalación del aparato. NO PERMITA que los cables estén en contacto con ninguna superficie de borde afilado. El hacerlo, causará daño o cortará el aislamiento del cable, lo que podría causar serios daños o la muerte por choque eléctrico.
9. NO USE bombillas (focos) de mayor cantidad de vatios que el máximo mencionado en el aparato. Usar bombillas de más vatios que lo especificado aumentará la temperatura y provocará un riesgo de incendio.
10. Si se utiliza un reductor de intensidad de luz con este aparato, obtenga asesoría profesional para determinar el tipo correcto y el amperaje necesario.



VIS-01

Drawing 1 – Hanging Instruction

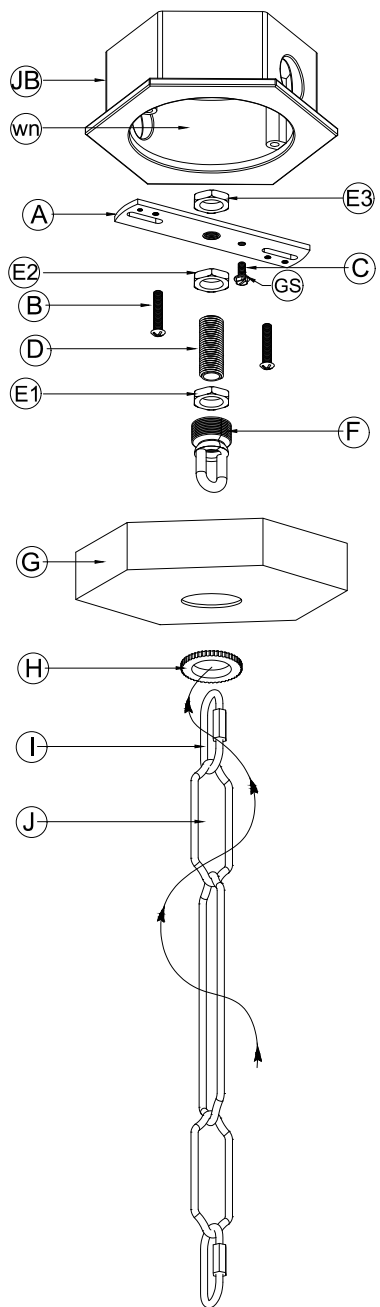

Drawing 2 – Canopy Adjustment

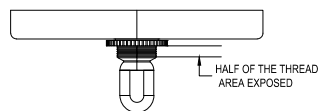

NOTE: Please consult a qualified electrician if you are not certain of installation or servicing.

CAUTION:

- Before starting installation or servicing, disconnect power by turning off the circuit breaker or by removing the fuse at the fuse box.
- These instructions are provided for your safety. It is very important that they are read carefully and completely before beginning the assembly of this lighting fixture.
- **SAVE THESE INSTRUCTIONS**

To Assembly:

1. Carefully unpack the fixture, spread out fixture, and lay out all parts on a clean surface.
2. Fasten mounting strap (A) to outlet box (JB) with the two screws (B).
3. Thread 2-hex nuts (E1) and (E2) onto threaded nipple (D).
4. Thread one end of threaded nipple (D) into collar loop (F) a minimum of $\frac{1}{2}''$ to $\frac{3}{4}''$.
5. Thread other end of threaded nipple (D) into mounting strap (A) approximate $\frac{1}{2}''$.
6. Slip canopy (G) over collar loop (F) and adjust height of loop so half of the threaded area on the loop is exposed - see Drawing 2.
7. After collar loop (F) height is adjusted, tighten hex nut (E2) up against mounting strap (A), and tighten against mounting strap to lock loop and nipple in position.
8. Remove mounting strap (A) from J-box and thread third hex nut (E3) onto end of threaded nipple (D) above the mounting strap (A), tighten against mounting strap (A) to lock assembly in position.
10. Remount mounting strap (A) to junction box.

1. Taking the chain (J), determine the length you require to hang the fixture
2. Attach one of the speed link (I) to top loop of the fixture and connect into chain .
3. Now slip collar loop (F) and canopy (G) onto chain. - see Drawing 2.
4. Attach 2nd speed link to collar loop (F). Get assistance for this step since fixture may be heavy and difficult to hold while attaching the chain.

1. Unwrap fixture lead wire and ground wire and weave them up through the chain.
2. Slip fixture lead wire and ground wire through the center of the collar loop (F).
3. Connect ground wire to mounting strap (A) using green ground screw (GS).
4. Make electrical connection from supply wire to fixture lead wires. Refer to Wiring Guide (WG) and follow all instruction to make all necessary connections.
5. Slip canopy up firmly against the ceiling and secure by turning the collar ring (H) on collar loop (F) until tight.

Wiring Guide

Reminder:

Read the safety instructions on page 2 of this manual before installing this fixture. This fixture requires two people for installation.

Advertencia:

Lea las instrucciones de seguridad en página 2 de este manual antes de instalar este artefacto. Este artefacto requiere dos personas para instalarlo.

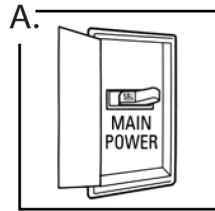

A. Shut off main power at the circuit breaker or fuse panel before removing old fixture.

Corte la electricidad en la caja principal de fusibles (o la caja del interruptor automático) antes de quitar el artefacto viejo.

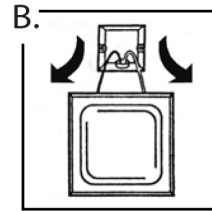

B. Remove old fixture. Disconnect wiring.

Quite el artefacto viejo. Desconecte los cables viejos.

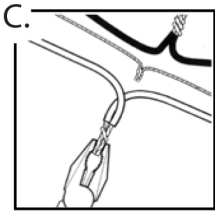

C. Strip 1/2" of insulation from wire ends. Twist stripped ends together with pliers. Connect fixture Hot wire to house Hot wire, fixture Neutral wire to house Neutral wire and fixture Ground to house Ground wire.

Helpful hint:
If necessary attach copper ground wire to grounded junction box.

Pele 1/2" de aislamiento de los extremos del cable. Gire los extremos pelados con alicates. Conecte el accesorio Cable caliente a la casa Cable caliente, accesorio Cable neutro a la casa Cable neutro y accesorio Tierra a tierra Cable a tierra.

Consejo útil:
Si es necesario, fije el cable de cobre a tierra a la caja de salida con conexión a tierra.

Helpful hint: Wire types and identification

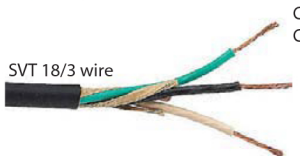
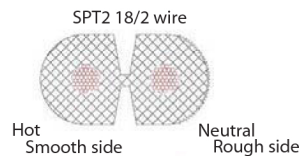

Ground
Green or
Clear with Green Stripe or
Clear with Yellow Stripe

Hot
Black or
Clear with Black Stripe or
Clear with Black Lettering

Neutral
White or
Clear with White Stripe or
Clear no markings

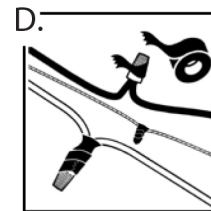

D. Attach wire nuts. Tape nuts and wire together.

Coloque los conos aislantes para empalmes. Usando cinta aislante, fije los cables y los conos.

Troubleshooting Guide

Minor problems can often be fixed without an electrician. Before attempting any repair on this light fixture, turn off electricity at circuit breaker box (or main fuse box).

Problem	Cause	Solution
Bulb Won't Light	Bulb Burnt Out	Replace Bulbs
	Power is off	Check if power supply is on
	Bad Wire Connection	Check Wiring
	Bad Switch	Test or replace switch
The fuse or circuit breaker trips when the fixture is turned on	Wires are crossed or power wire is contacting ground wire	Check wire connections

Cleaning

Shut off main power supply.
Clean fixture with a damp cloth.
Do not use abrasive cleaners.

Guía para solución de problemas

Los problemas menores frecuentemente se pueden solucionar sin llamar a un electricista. Antes de intentar cualquier tipo de reparación, corte la electricidad en la caja principal de fusibles (o la caja del interruptor automático).

Problema	Causa	Solución
Las bombillas no dan luz	La bombilla se ha fundido	Reemplace la bombilla
	La electricidad está apagada	Verifique si está conectada la electricidad
	Hay cables mal conectados El interruptor está dañado	Revise las conexiones Pruebe o reemplace el interruptor
Se funde el fusible o se activa el interruptor automático cuando se prende la luz	Los cables están cruzados o el cable positivo esta en contacto con el cable a tierra	Revise las conexiones de los cables

Limpieza

Apague la electricidad en la caja principal de fusibles o el interruptor automático.
Limpie el artefacto con un trapo húmedo. Use líquido de limpiar ventanas solo para limpiar las pantallas de vidrio. No use limpiadores abrasivos.



Questions, problems, missing parts? Contact our Customer Care Center: 1-702-792-6900

Tiene preguntas, problemas, o faltan partes? Comuníquese con nuestro centro de Atención al Cliente: 1-702-792-6900